



FISHABILITY



LUXURY



RELIABILITY



2600 WA

OWNER'S MANUAL

2017

WELCOME

Congratulations on becoming the owner of a new Century Boat! And welcome to the Century Boats family.

You are now the owner of a world-class, high-performance vessel – and we are excited to introduce you to our worldwide and ever-expanding family of boating enthusiasts.

This Owner's Information Packet should be kept aboard your Century Boat and will provide important information about features of your specific model.

For years of trouble-free boating, take the time to carefully review the information in this packet and really get to know your boat. Also, please have everyone who will operate your boat read the Owner's Manual.

The Owner's Information Packet contains the following:

Model-Specific Owner's Manual

The Model Specific Manual contains information specific to your model.

Century Boats General Information Manual

The Century Boats Owner's Manual contains important operating and safety information, as well as reminding you about your responsibilities as a boat owner/operator.

Original Equipment Manufacturer (OEM) Information

Additional OEM information may be included. The OEM Information section of your Owner's Information Packet may contain information provided by individual systems manufacturers of equipment installed on your boat. Examples include the engine, engine control and electronics equipment. Throughout the Owner's Manual you may be referred to information provided by manufacturers of specific systems.

Because your purchase represents a substantial investment, we know you will want to take the necessary measures to protect its value. We have outlined a program for proper operation, periodic maintenance and safety inspections. We urge you to follow these recommendations. If you have questions which are not fully covered by the Owner's Information Packet, please consult your authorized Century Boats dealer for assistance.

Thank You for Selecting a Century Boat!
Happy Boating

TABLE OF CONTENTS: 2600 Walk Around

Load Capacity.....	1
Passenger Locations.....	3
Safety Label Locations.....	4
Function & Location of Through-Hull Outlets.....	5
Helm, Gauge & Switch Layout.....	6
Deck Layout.....	7
Deck Layout, bow rail removed.....	8
Courtesy, Map, Spreader Lights.....	9
Bilge Area Layout.....	10
Fire Extinguisher Location & Function.....	11
Fuel System.....	11
Water System.....	11
Entertainment System.....	11
Upholstery Care.....	11
Corrosion: Anodized Aluminum/Stainless Steel.....	12
Electrical Schematics.....	14

Information in this publication is based upon the latest product specifications available at printing.

Century Boats reserves the right to make changes at any time, without notice, in the colors, equipment, specifications, materials and prices of all models, or to discontinue models. Should changes in production models be made, Century Boats is not obligated to make similar changes or modifications to models sold prior to the date of such changes.

Printed in the U.S.A. September 2016

Century Boats, 40047 CR 54 East, Zephyrhills Florida 33540

Note: Not all accessories shown in pictures or described herein are standard equipment or even available as options.

Load Capacities / Specifications

Capacity Plate

MAXIMUM WEIGHT CAPACITY (Pounds, Persons, Motor, Gear) (Lbs.)	Yacht Certification
PERSONS (Quantity)	Yacht Certification
PERSONS (Lbs.)	Yacht Certification
MAXIMUM HORSE POWER	450 HP

Specifications

L.O.A. (Feet & Inches)	26'-0"
BEAM (Feet & Inches)	102" (8'-6")
DEADRISE (Degrees)	20°
WEIGHT LESS ENGINE (Lbs.)	5800
TRANSOM ANGLE (Degrees)	15°
TRANSOM HEIGHT (Inches)	30"
TRANSOM WIDTH (Inches)	94"
COCKPIT DEPTH, REAR TO FRONT (Inches)	26" to 28"
FREEBOARD, MID-SHIP (Inches)	46"
FREEBOARD, AFT (Inches)	18 ½"
DRAFT, HULL (Inches)	15"
HEIGHT, KEEL TO TOP OF CONSOLE (Inches)	122"
BRIDGE CLEARANCE, WL TO WINDSHIELD (Inches)	84"
BRIDGE CLEARANCE WITH TOP (Inches)	112"
CABIN HEIGHT/ WIDTH (Inches)	70" / 87 ½"
MACHINERY COMPARTMENT HEIGHT/WIDTH (Inches)	33" / 38"

Capacities

FUEL TANK (Gallons)	Center	138
FRESHWATER TANK (Gallons)	Aft Stbd Corner	14

HOLDING TANK (Gallons)	Mid ship Forward Con	7
BAIT WELL (Gallons)	Aft (Transom)	42
INSULATED COOLER UNDER LEAN POST (Quarts)	Hel Seat	65
FISHBOX (Quarts)	Cockpit Floor (P & S)	144 x 2
TUB-STORAGE (Cubic Feet/Gallons)	Stbd Seat	2 Cu. Ft./15 Gal
ANCHOR LOCKER (Cubic Feet)	Bow	10 Cu. Ft.

Trailer Data

L.O.A. (Feet & Inches)	26'-0"
KEEL LENGTH (Feet & Inches)	24'-0"
KEEL LENGTH, STERN TO BOW EYE (Feet & Inches)	21'-7"
HEIGHT, KEEL TO BOW EYE (Inches)	34"
TRANSOM WIDTH AT CHIMES (Inches)	88 ¾"
CHINE WIDTH (Inches)	4"
OUTSIDE WIDTH AT OUTER STRAKES (Inches)	63 ¾"
STRAKE WIDTH (Inches)	3 7/8"
OUTSIDE WIDTH AT INNER STRAKE (Inches)	32"
STRAKE WIDTH (Inches)	2 ¾"
VERTICAL DIM. FROM KEEL TO CHINE (Inches)	14 ½"
BEAM MID-SHIP (Inches)	102"

Engines Options

Twin	F150XB	w/Yamaha Prop: 14 ¼" x 17 L/R
Twin	F200XCA	w/Yamaha Prop: 14 ¼" x 17 L/R
Twin	F225UCA	w/Yamaha Prop: 15 ½" x 17 L/R
Single	F350UCA	w/Yamaha Prop: 15 ½" x 21

1. Passenger Locations

Any marine vessel larger than twenty-six feet (26') is classified by NNMA as a yacht. These vessels do not have any specific passenger or weight requirements. It is the responsibility of the vessels captain to insure his/her vessel is seaworthy and is not over loaded. Century Boats as the manufacturer recommends the following:

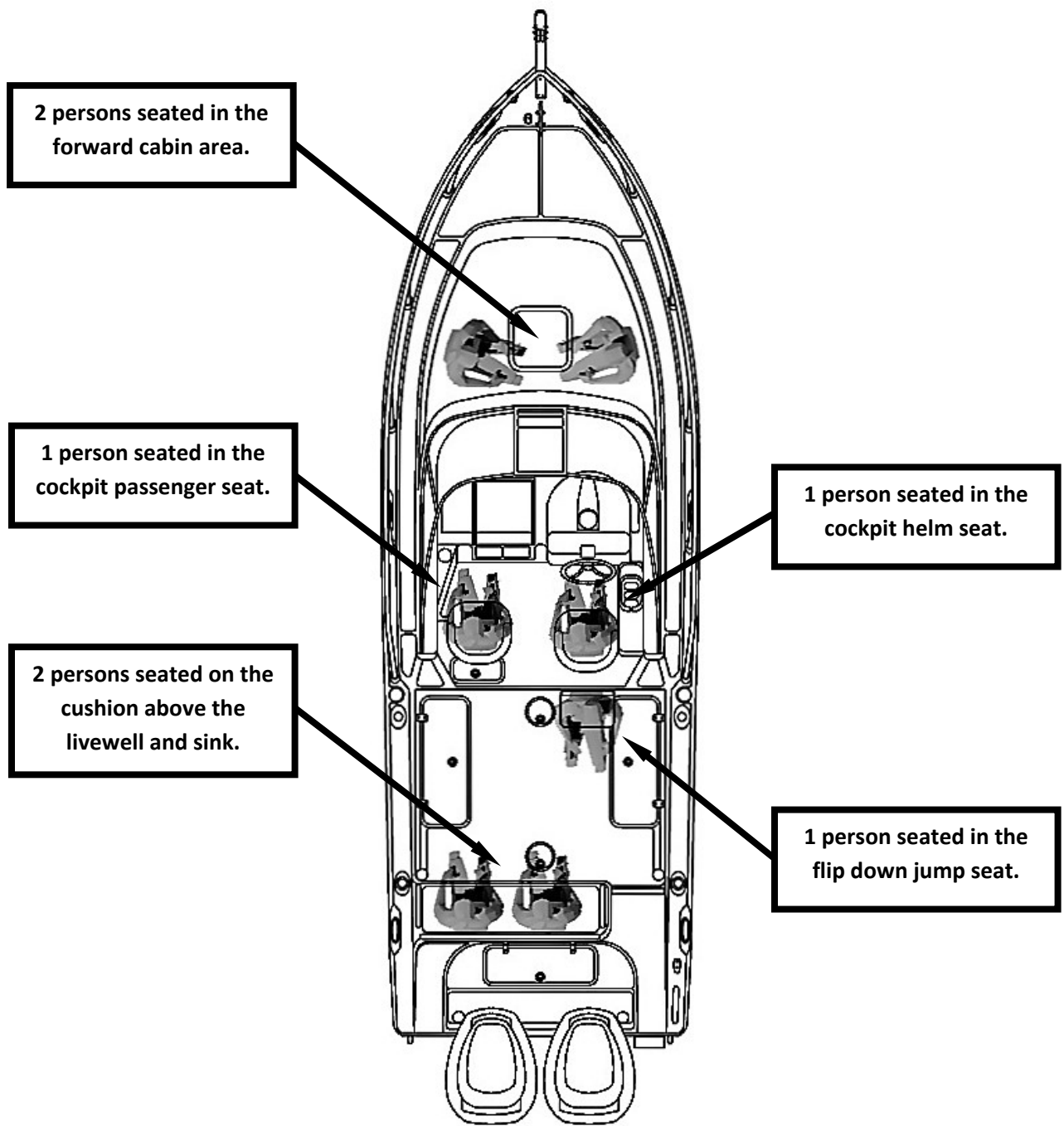

2. Safety Label Locations

There are several locations where safety labels appear. It is the responsibility of all boat owners and their passengers to read and adhere to the safety warning labels to prevent serious harm or even death.

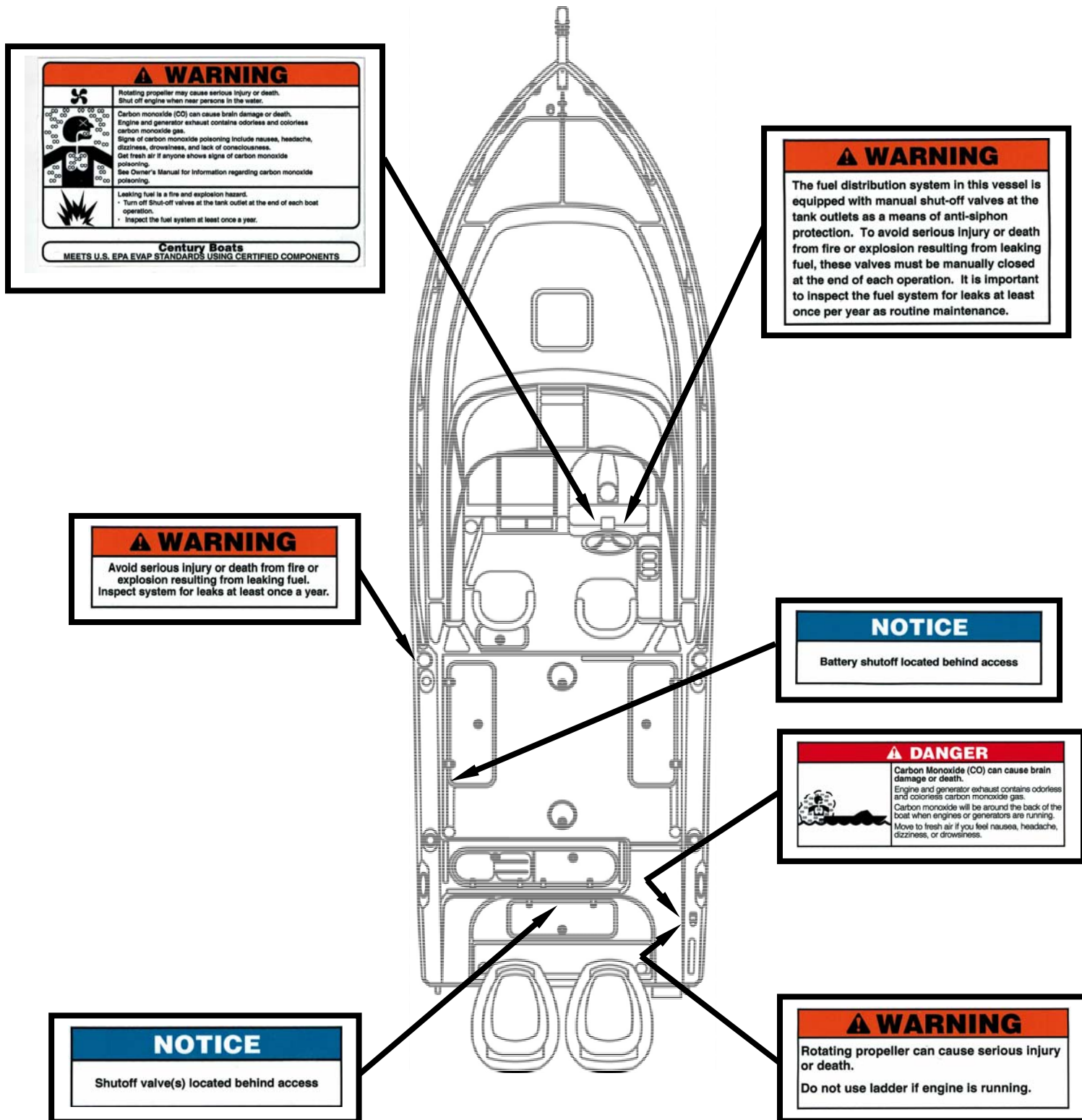

3. Location & Function of Through-Hull Outlets

The function of each through-hull outlet is to allow for the proper drainage of excess water from the designated areas.

Starboard Side:

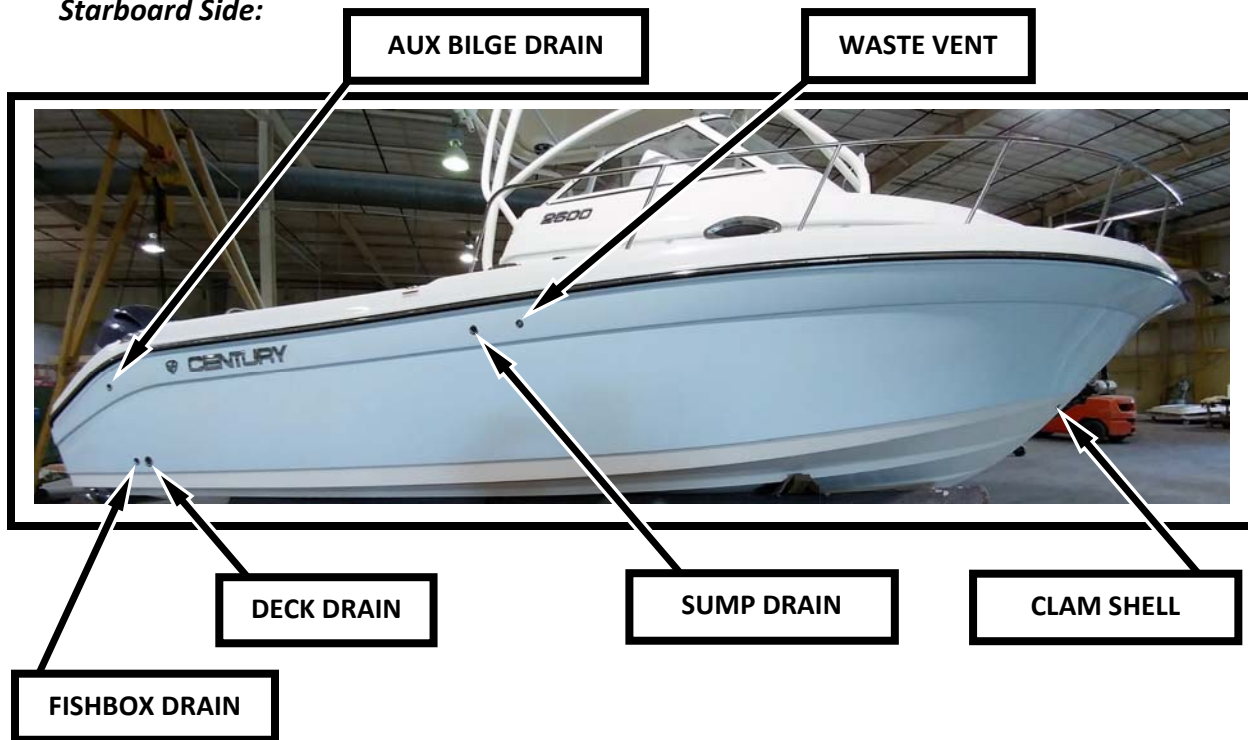

Port Side:

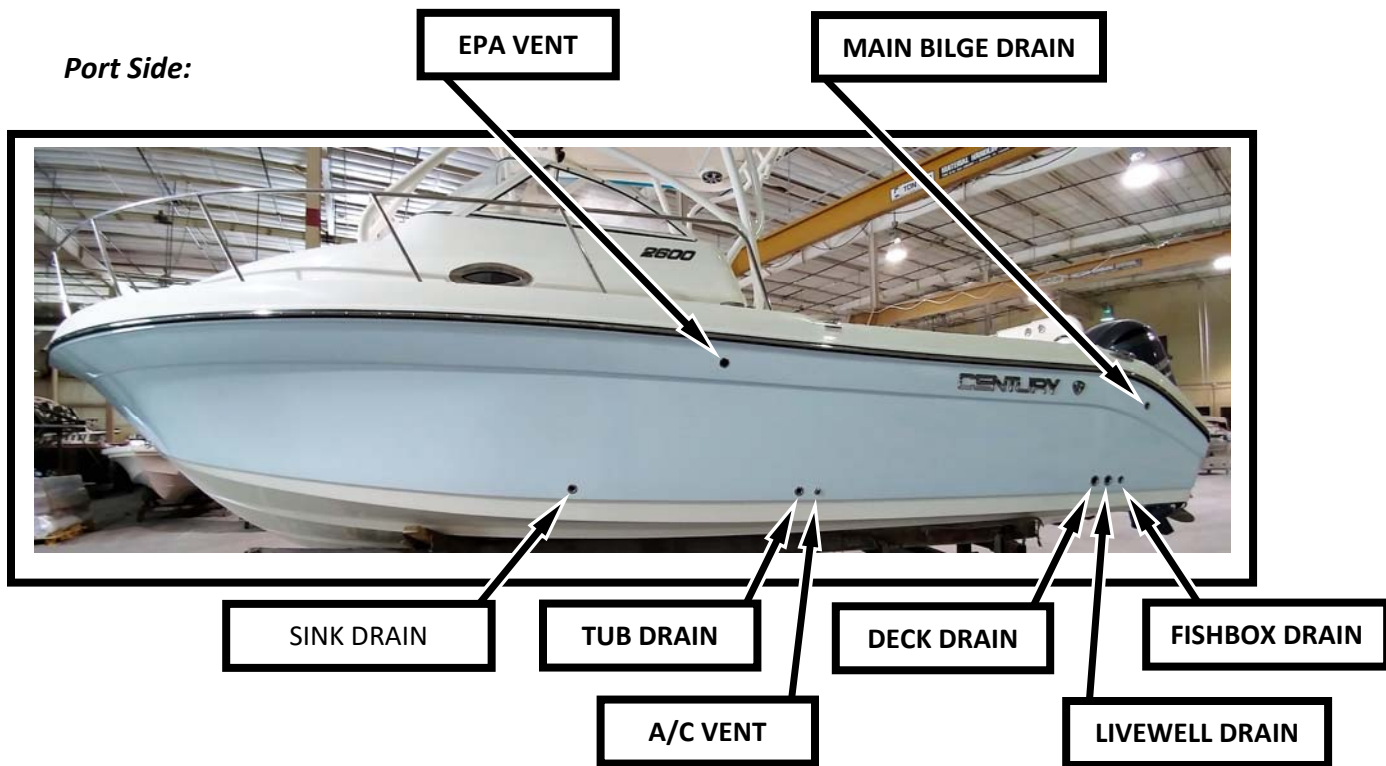

4. Helm, Gauge & Switch Layout

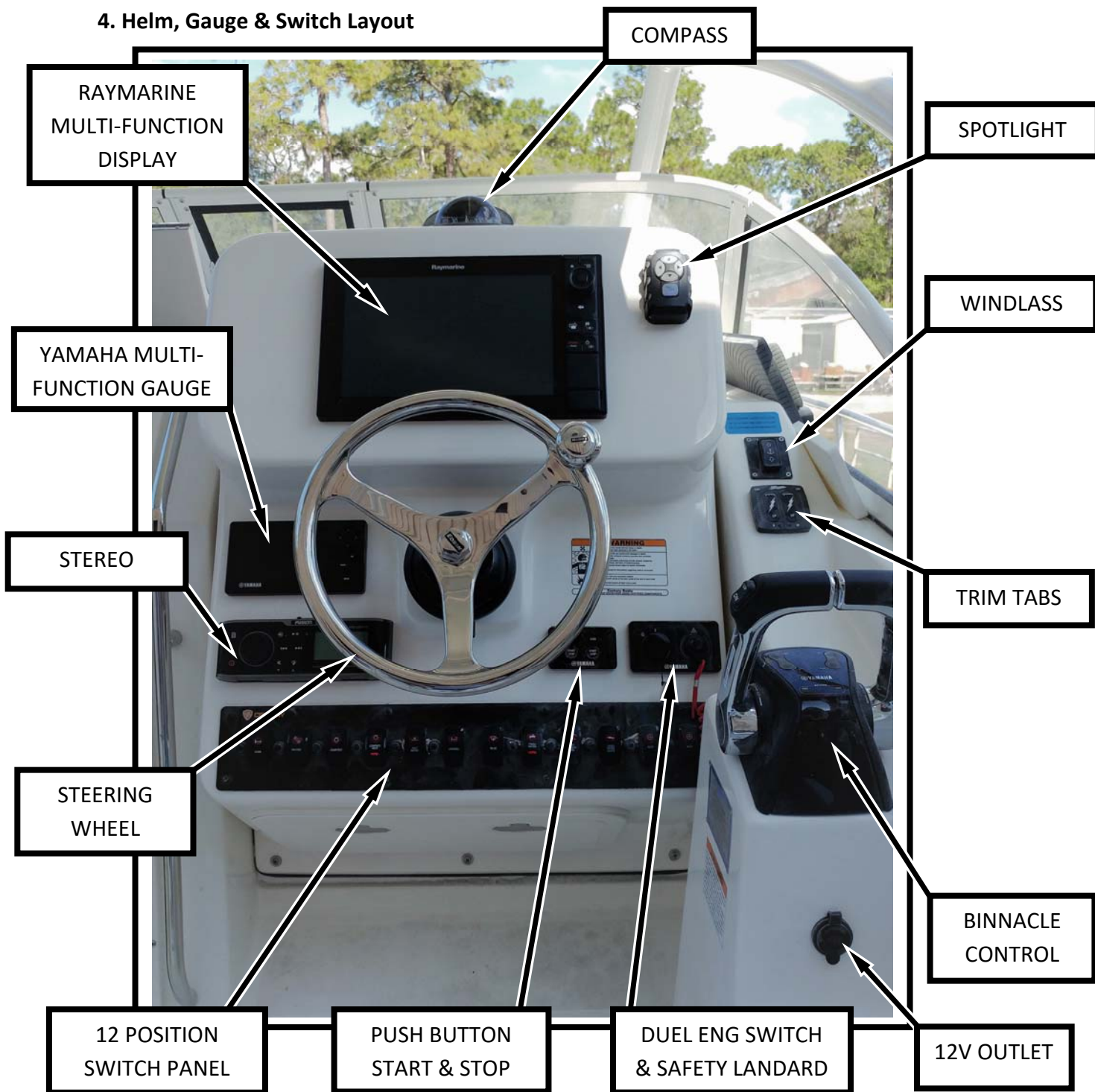

12 POSITION SWITCH PANEL: (RIGHT TO LEFT)

- | | | | |
|--------------------|--------------|-------------|----------------|
| 1. HORN | 2. NAV/ANC | 3. COURTESY | 4. COMPARTMENT |
| 5. RAW WATER | 6. LIVEWELL | 7. BILGE | 8. FRESHWATER |
| 9. SPREADER LIGHTS | 10. HARD-TOP | 11. MAP | 12. ACCY |

5a. Deck Layout: for items not shown in this figure, see 5b on next sheet.

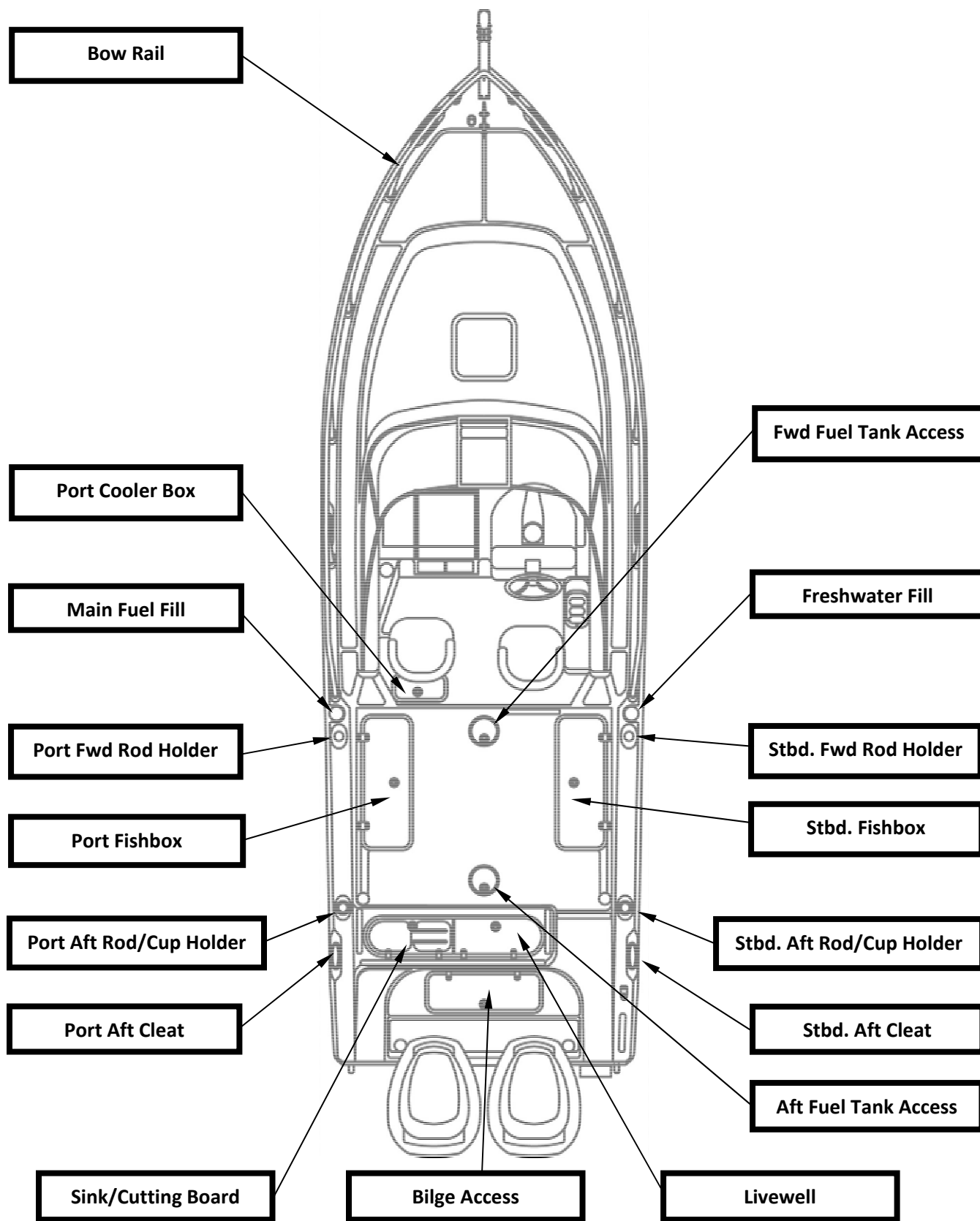

5b. Deck Layout: with bow rail removed for clarity.

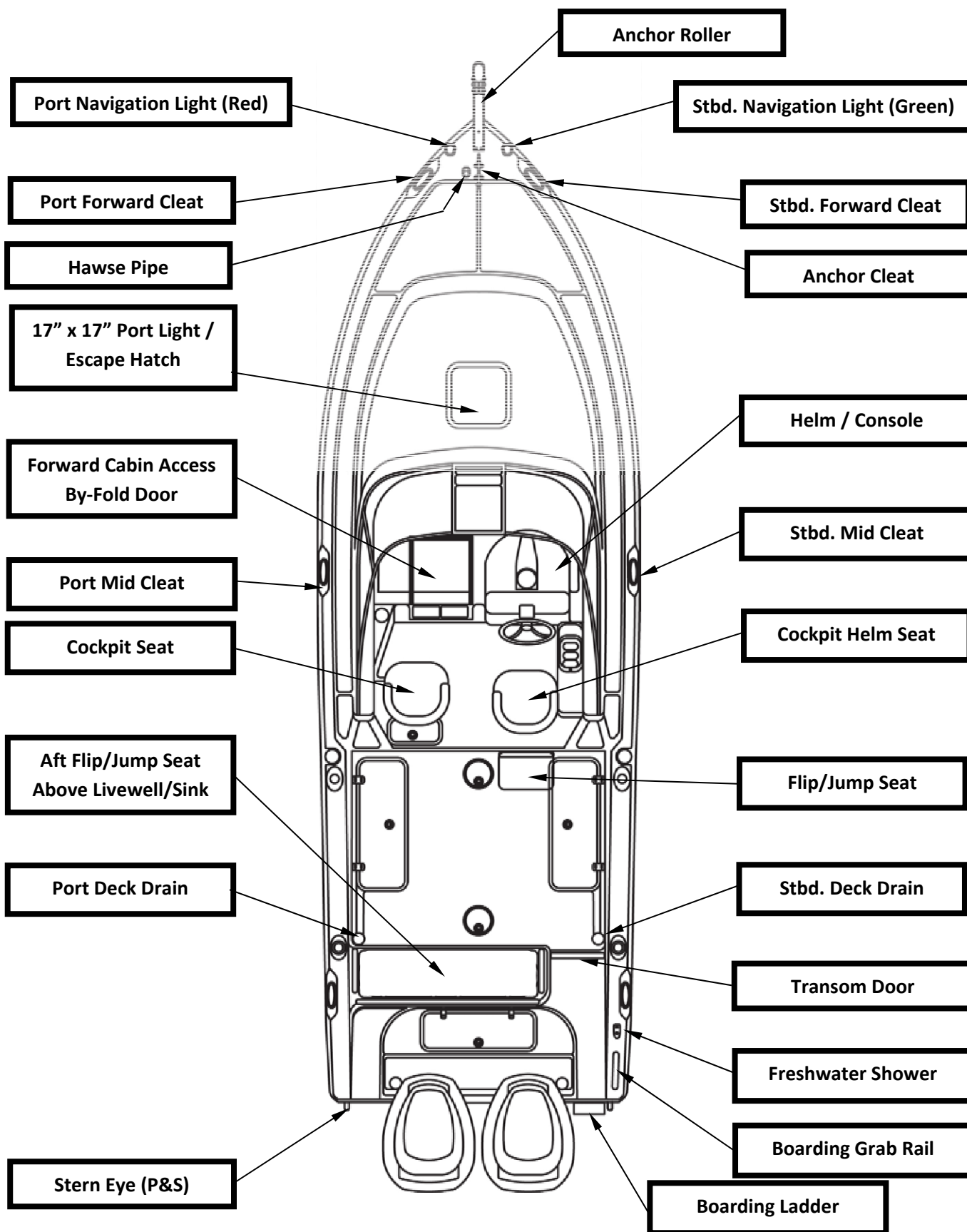

6. Courtesy Lighting

Courtesy Lights: There are five units located in the main deck area. One unit each (2) above the port and starboard steps to the gunwales. One unit in the aft wall above the center step from the main deck to the cockpit. One unit in the forward wall of the step from the transom walkway to the main deck. One unit in the forward wall between the flip-up seat and the port wall just above the deck.

There are also four units located in the hard-top, one aft, one forward, one port and one starboard located in the raised portion of the hard-top.

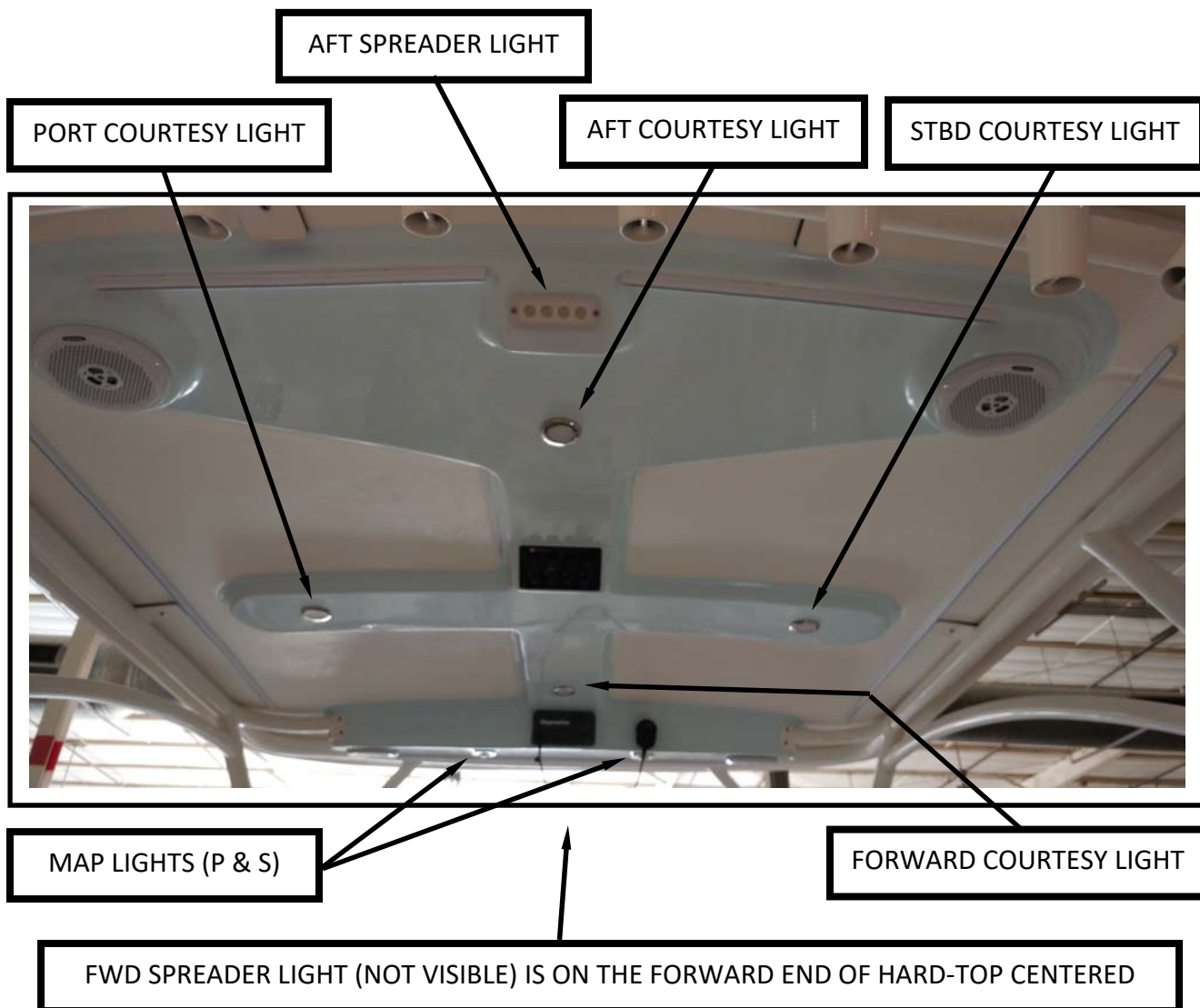

Map lights: There are two units located on the port and starboard underside of the forward raised portion of the hard-top, directly above the helm and the passenger console area.

Spreader Lights: There are two units, one located at the forward end of the hard-top in the center to light up the bow area. The second is located at the aft end of the hard-top in the center to illuminate the main deck seating area.

7. Bilge Area Layout

The bilge area can be accessed through the bilge hatch, located between the motors and the livewell.

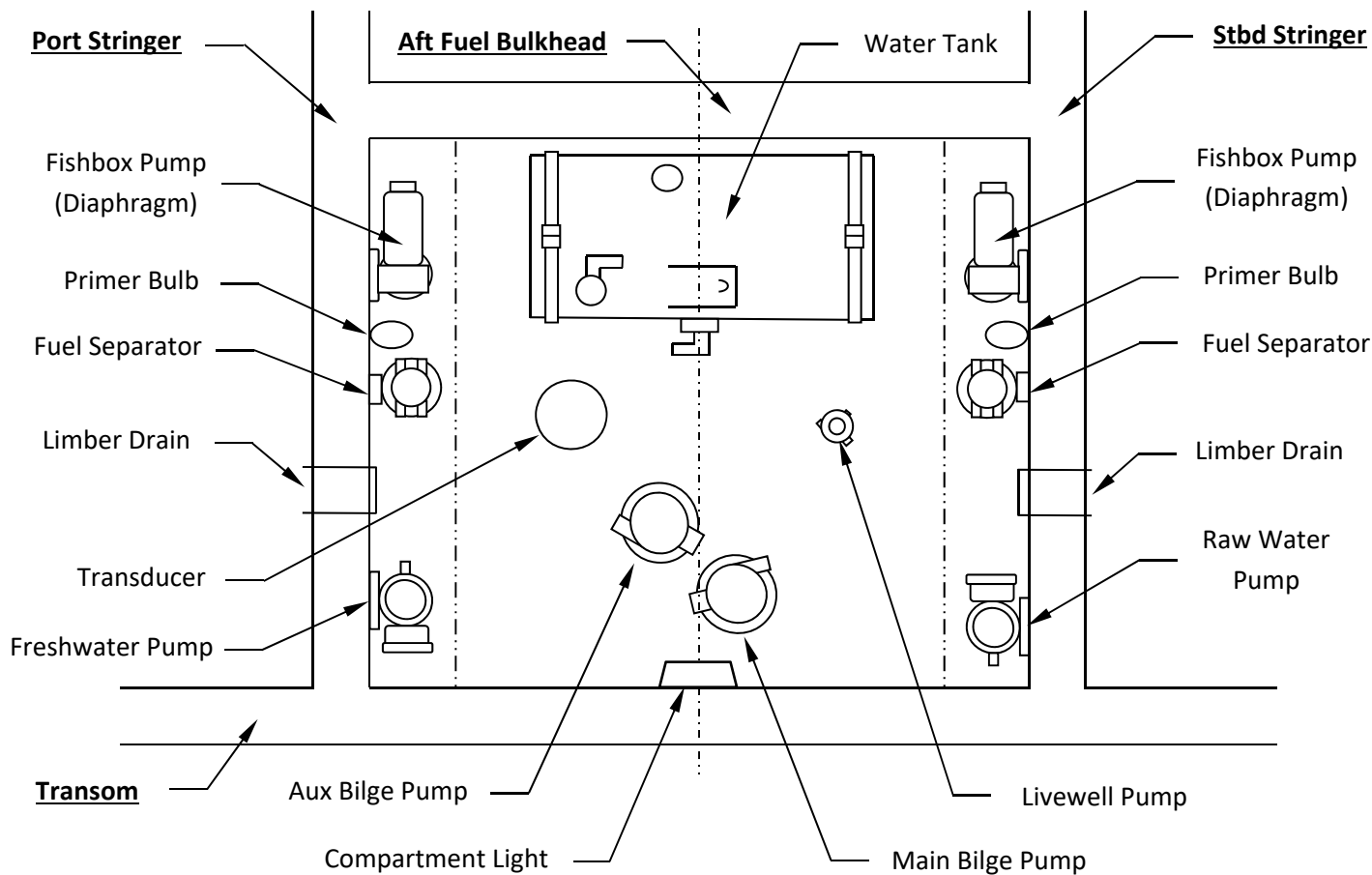

8. Fire Extinguisher Location & Function

The owner is required to purchase an approved fire extinguisher. The fire extinguisher shall be approved by the U.S. Coast Guard and classified as B-I or B-II.

9. Fuel System

The 26 Walk Around is equipped with a primary fuel tank located in the center of the stringers and is accessible through two circular ports located in the floor of the main deck. The forward port located just aft of the step up to the cockpit allows access to the fill and vent hoses. The aft port located in the center of the deck in front of the livewell tank allows access to the sending unit and sensors. The fuel tank has a capacity of 138 gallons. The fuel fill and vent hoses run from the forward end of the tank to the port side and connect to the fuel fill located on and centered in the port gunwale.

10. Freshwater System

The freshwater system is in the bilge area. Access to the freshwater tank is through the bilge access door. The freshwater tank has a capacity of 14 gallons. The freshwater pump is mounted just forward of the transom on the port wall of the bilge, the fill and vent hoses run from the tank along the starboard stringer to the water fill. The freshwater fill is located on and centered in the starboard gunwale. The aft hose connects to the transom shower. The transom shower is in the starboard gunwale, between the starboard aft cleat and the boarding grab rail.

11. Entertainment System

The Fusion entertainment system on your boat is designed specifically for the marine environment. The stereo mounts in the helm compartment and has four speakers. Refer to the Fusion owner's manual for available functions and proper operating procedures.

12. Upholstery Care

The vinyl material used on the seats and bolsters is of a high-quality marine material. **DO NOT** use harsh cleaners, solvents or chemicals on your vinyl surfaces. For best results, it is recommended that the owner does a deep cleaning at least twice a year. A periodic surface wipe down of all the vinyl material is recommended after each use. Mix ½ gallon of water with 2 tbsp. of dish washing liquid. Scrub the surface of the marine upholstery as well as below the seats and all the seams throughout your vessel. It is **VERY** important **NOT** to stow wet cushions. Let them air dry before stowing. This will prevent mold from growing on your upholstery.

13. Corrosion: Anodized Aluminum/Stainless Steel Care

The anodized aluminum and stainless steel chosen for construction of the hard-top, t-top, Bimini top or other marine fabrication on your new boat has been produced to a marine specification designed to achieve the very best overall performance.

Despite the use of the very best materials for this application, the marine environment is one of the harshest on the planet. The marine environment, atmospheric contaminants and normal wear and tear will all contribute to the onset of “pitting” on the metal’s surface. The best way to combat the aggressive nature of the marine environment and to keep the aluminum and stainless steel on your new boat in “like new” condition is through proper cleaning and preventive maintenance. With proper care and maintenance, the anodized aluminum and stainless steel on your boat can be kept in first class condition for a very long time.

The aluminum on your boat has been anodized, which creates a very hard protective seal on the surface of the aluminum to protect it from pitting. When the anodized coating is broken and raw aluminum is exposed, corrosion will take place. Damage from knives, gaffs or other abrasive impacts can break the anodized coating.

Corrosion is a natural phenomenon that affects metals by either a chemical or electrochemical reaction. The rate at which aluminum corrodes depend greatly on the environmental conditions and the amount of preventive maintenance performed. Our goal is to slow down or stop this natural phenomenon we call pitting (or corrosion).

Be aware corrosive chemicals containing high concentrations of acids or alkalis will remove the anodized coating. Solutions containing chlorine, salts, or ammonia are all harmful to the anodized aluminum on your boat. Many common household cleaners contain the chemicals that, if used, will be harmful to the anodized aluminum parts on your boat.

Avoidable:

- Strong acidic solutions found in cleaners, paint remover, degreasers, etc.
- Concentrated alkaline based solutions. Many, if not most soaps fall into this category.
- Chlorine, sulfurs, solvents and ammonia-based products.

Unavoidable:

- Saltwater (often comes with the territory).
- Airborne pollution. Airborne particles from local sources: vehicles, incinerators, paper mills, chemical plants, power plants, etc.
- Harsh chemicals from work performed at local shipyards and dry docks.
- Be aware of local sources that can expose your new boat to corrosive chemicals.

It’s most important to clean and rinse well.

DO IT OFTEN! DO IT PROPERLY! How often you need to wash your boat depends on how often you use it and your local environment. You should clean your boat each and every time you use it. If the boat is stored in a marine environment, it will need to be cleaned more often. If the local conditions expose the aluminum or stainless steel to harsh chemicals, then washing on a regular basis is highly recommended.

KEEP IT SIMPLE! Always use a mild, non-abrasive soap and lots of **FRESH** water (not saltwater). Thoroughly wash the aluminum with a soft towel or sponge. Using lots of soap and water will remove dried salt crystals and other contaminants. Rinse completely with direct water pressure.

As well, the stainless steel on your boat has corrosion-resistant qualities which are inherent to the metal itself. These qualities help the stainless steel form an iron chromium oxide film which in turn protect it from forming rust.

If there are signs of rusting:

- Wash with **Fresh** water and a high-quality detergent
- Clean with an automobile chrome polish
- Wax with an automobile or fiberglass wax
- For brushed finishes... those finishes that show grit lines, an abrasive cleaner or sand paper can be used. Always test a small area first and go in the same direction of the grain

Avoidable:

- **DO NOT** clean with chlorinated cleaners (NO BLEACH) or scouring powders.
- **DO NOT** use sand paper or abrasive cleaners on buffed or mirror finished metals.
- **DO NOT** clean with muriatic or hydrochloric acids.

Important Tips: Wash with lots of freshwater

- Wash often enough to keep contaminants from forming or building up.
- Avoid the use of bleach or chlorides to clean aluminum, stainless steel, or nearby components. Chlorides can leach into the metal when used nearby.
- **Avoid abrasive cleaning products.** For anodized aluminum products, **NEVER** use steel or brass wool, wire brushes, polishing wheels, rubbing or polishing compounds. These items will remove the anodizing and will lead to pitting.
- Pay close attention when cleaning the pipe and tubing directly beneath the top or canvas. These areas do not receive the natural rinsing action of rainwater. The area is shielded from the sun and does not dry as completely or as quickly as the rest of the frame. It is often overlooked when cleaning the boat. This area is likely to be the first place that staining or pitting will occur.

14. Electrical Schematics

The following schematic drawings will provide a reference for you if you need to trace the wiring or electronic components on your boat. Schematics 1-4 provide data on the battery panel, main harness, bilge and the forward deck harness. Schematics 5-8 provide data on the console/helm and hard-top.

15a.) Battery Cable Diagram:

2awg red (2x), 2/0awg red (2x), 4awg red (2x), 2/0awg yellow (2x), 2awg yellow (1x), battery switch located in the STBD rod box:

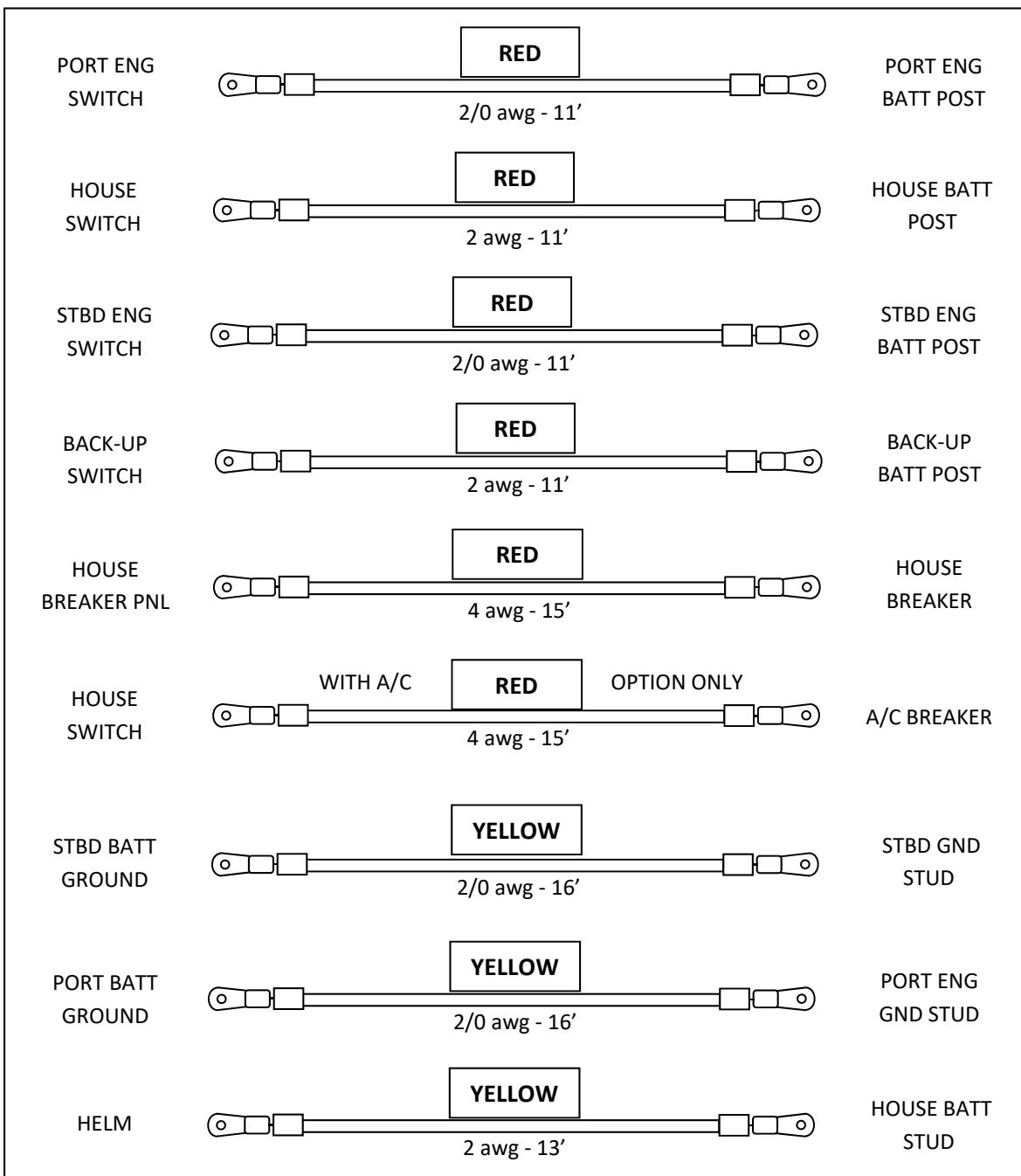

15b.) Wire Identification and Function:

Use the follow guide with the schematics when tracing your wires.

12 VOLT DC WIRE IDENTIFICATION GUIDE	
STBD REAR SPEAKER (+)	VIOLET / RED STRIPE
STBD REAR SPEAKER (-)	VIOLET / YELLOW STRIPE
PORT REAR SPEAKER (+)	GREEN / RED STRIPE
PORT REAR SPEAKER (-)	GREEN / YELLOW STRIPE
STBD FWD SPEAKER (+)	GRAY / RED STRIPE
STBD FWD SPEAKER (-)	GRAY / YELLOW STRIPE
PORT FWD SPEAKER (+)	WHT / RED STRIPE
PORT FWR SPEAKER (-)	WHT / YELLOW STRIPE
SUB (+)	10awg WHT / RED STRIPE
SUB (-)	10awg WHT / YELLOW STRIPE
MANUAL BILGE / MISC PUMP	BROWN
BILGE PUMP FLOAT SWITCH (+)	BROWN / RED STRIPE
RAW WATER PUMP (+)	BROWN / WHT STRIPE
MISTER PUMP (+)	BROWN / GRAY STRIPE
FRESH WATER PUMP (+)	BROWN / BLUE STRIPE
MACERATOR PUMP (+)	BROWN / ORANGE STRIPE
PORT FISHBOX PUMP (+)	BROWN / PINK STRIPE
STBD FISHBOX PUMP (+)	BROWN / GREEN STRIPE
LIVEWELL PUMP (+)	BROWN / YELLOW STRIPE
TOILET (+)	BROWN / BLACK STRIPE
TOILET RAW WATER PUMP (+)	BROWN / LIGHT BLUE STRIPE
MISC. LIGHTS (+)	BLUE
COURTESY / COCK PIT LIGHTS (+)	BLUE / YELLOW STRIPE
COMPARTMENT LIGHTS (+)	BLUE / ORANGE STRIPE
UNDERWATER LIGHT (+)	BLUE / GREEN STRIPE
SPEADER LIGHT (+)	BLUE / BLACK STRIPE
TOP COUTESY LIGHT (+)	BLUE / WHT STRIPE
TOP MAP LIGHT (+)	BLUE / RED STRIPE
HEAD / CONSOLE LIGHT (+)	BLUE / BROWN STRIPE
SPEAKER LIGHT (+)	BLUE / PURPLE STRIPE
NAVIGATION / BOW LIGHT (+)	GRAY
ANCHOR LIGHT (+)	GRAY / BLUE STRIPE
HORN	ORANGE
VHF SENDER (+)	N2K ORANGE / YELLOW STRIPE
VHF SENDER (-)	N2K ORANGE / GREEN STRIPE
BONDING	GREEN
MISC. 12 V SYSTEM (+)	RED
NEGATIVE / GROUND	YELLOW

3.) Electrical Schematics: Bilge Harness

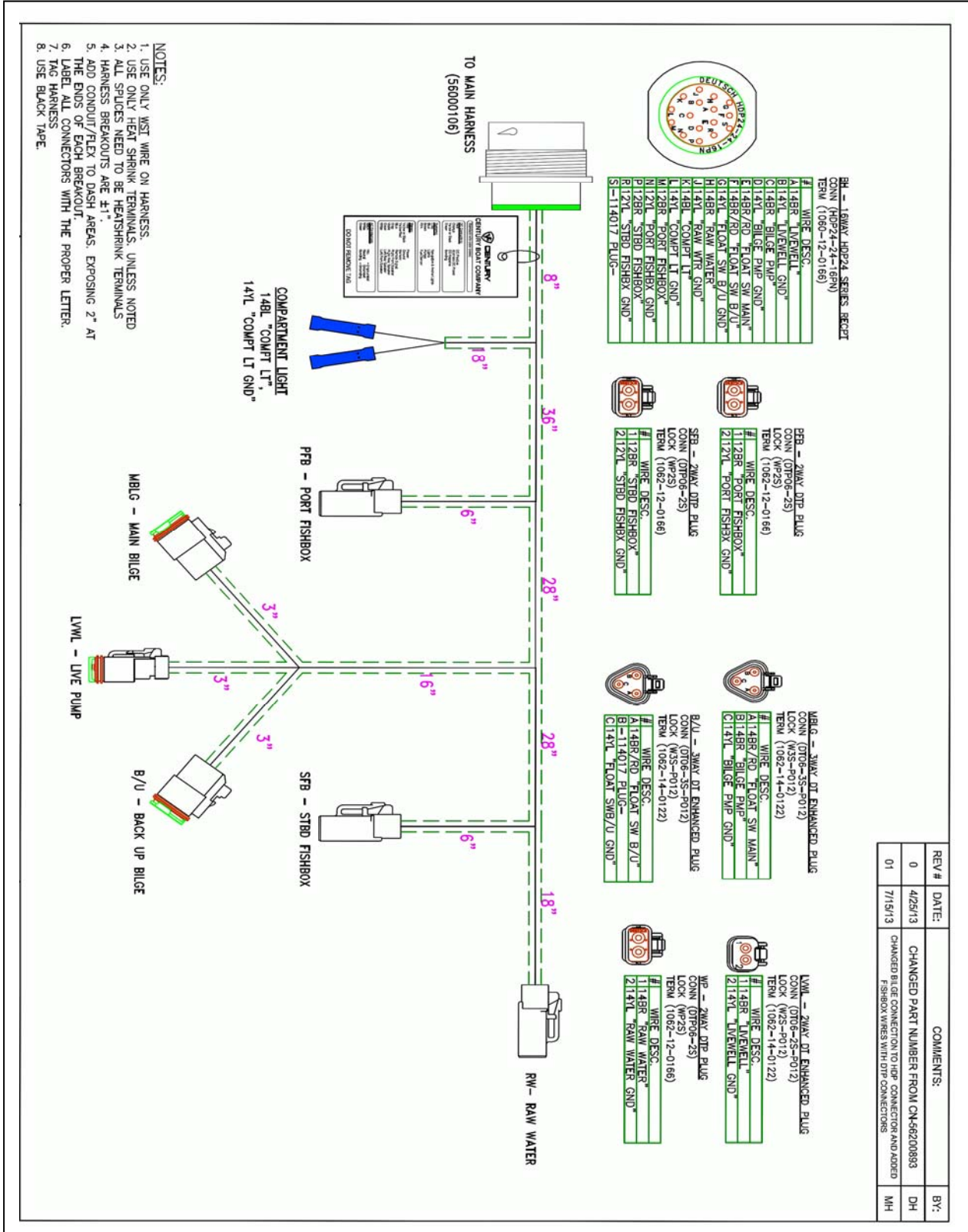

- NOTES:**
1. USE ONLY MST WIRE ON HARNESS.
 2. USE ONLY HEAT SHRINK TERMINALS, UNLESS NOTED
 3. ALL SPLICES NEED TO BE HEATSHRINK TERMINALS
 4. HARNESS BREAKOUTS ARE ±1"
 5. ADD CONDUIT/FLEX TO DASH AREAS. EXPOSING 2" AT THE ENDS OF EACH BREAKOUT.
 6. LABEL ALL CONNECTORS WITH THE PROPER LETTER.
 7. TAG HARNESS
 8. USE BLACK TAPE

REV #	DATE:	COMMENTS:	BY:
0	4/25/13	CHANGED PART NUMBER FROM CN-66200893	DH
01	7/15/13	CHANGED BILGE CONNECTION TO HRP CONNECTOR AND ADDED FISHBOX WIRES WITH DTP CONNECTORS	MH

6.) Electrical Schematics: Hard-Top Switch Panel (4 Position)

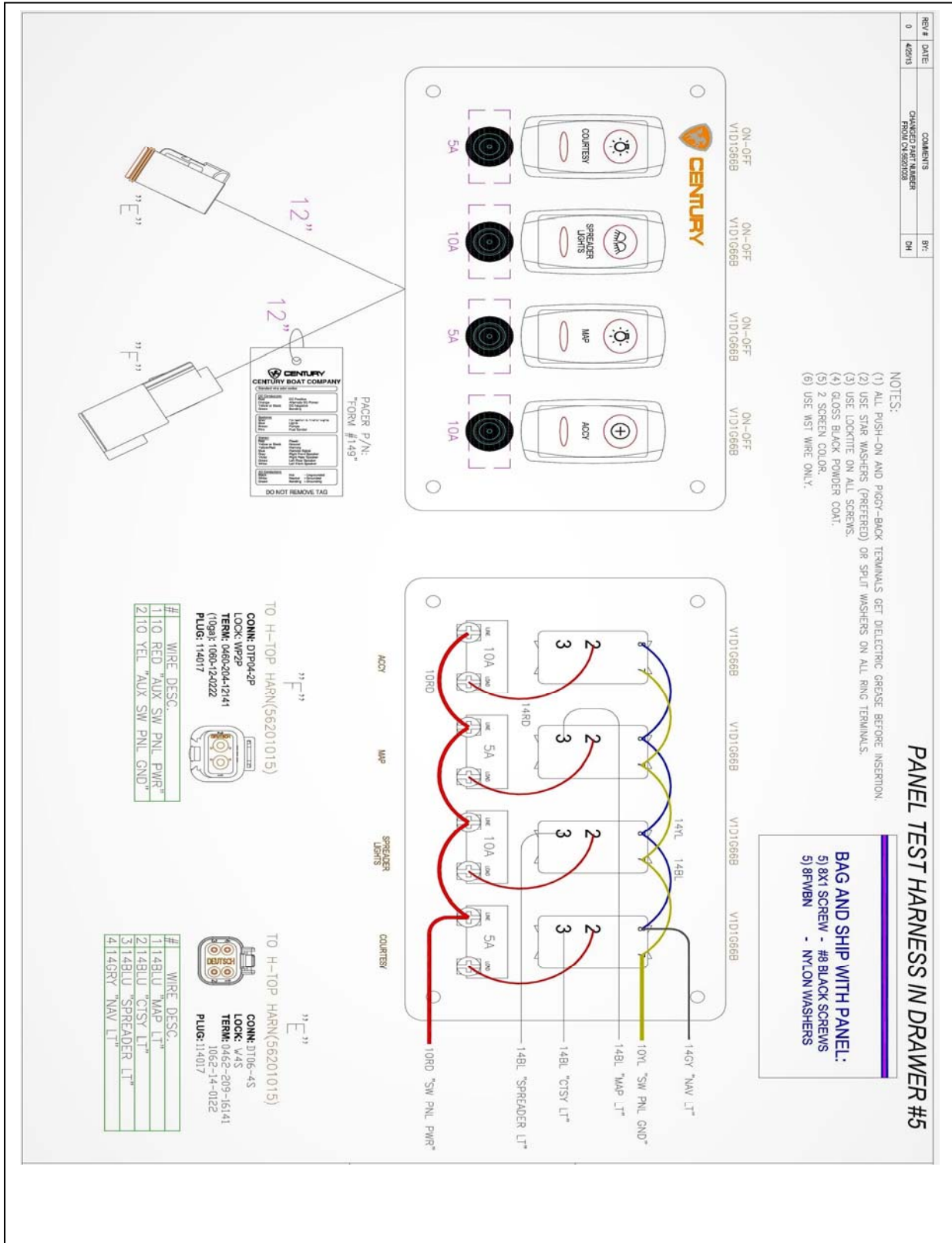

8.) Electrical Schematics: Forward Liner Harness (Cabin)

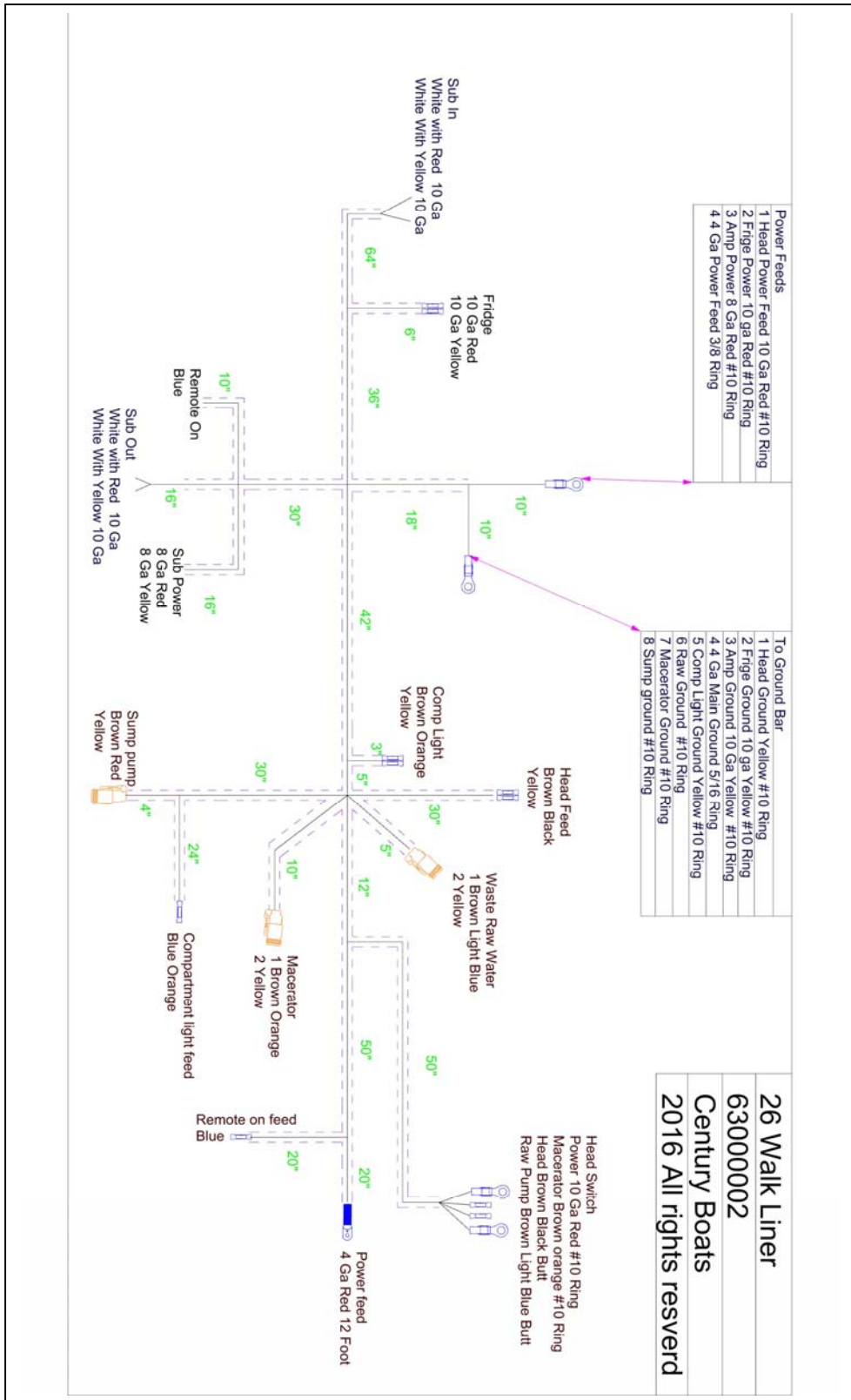

OWNER'S INFORMATION PACKET

GENERAL INFORMATION

TABLE OF CONTENTS: General Information

I. INTRODUCTION	
1. This Manual.....	1
2. Your Responsibilities.....	1
3. Sources of Information.....	1
4. Dealer Responsibilities.....	2
5. Warranties.....	2
6. Hull Identification Number (HIN).....	2
7. Manufacturer's Certification.....	3
8. Service, Parts and Repair for your Boat.....	3
II. SAFETY	
1. Introduction.....	4
2. Required Safety Equipment.....	4
3. Personal Floatation Devices (PFD).....	5
4. Recommended Equipment.....	6
5. Alcohol, Drugs and Water Safety.....	6
6. Rules of the Road.....	6
7. Minors.....	6
8. Passenger Safety.....	6
9. Water Skiing.....	7
10. Swimming.....	8
11. Hazardous Weather.....	8
12. Hazardous Conditions.....	8
13. Accidents.....	8
III. OPERATIONAL HINTS	
1. Fueling the Boat.....	10
2. Capacity.....	10
3. Boarding.....	11
4. Boat Weight Distribution.....	11

IV. BASIC OPERATION

1. Introduction.....	12
2. Shift / Throttle.....	12
3. Safety Stop Switch and Lanyard.....	12
4. Steering.....	13
5. Getting Underway.....	13
6. Maneuvering.....	14
7. Docking / Departure.....	14
8. Trim / Propeller Selection.....	15
9. Anchoring.....	16

V. SYSTEM / COMPONENTS

1. Instrument / Switch Panels.....	17
2. Electrical System.....	17
3. Fuses.....	17
4. Switches and Controls.....	18
5. Shift / Throttle.....	18
6. Fuel System.....	18
7. Bilge.....	19
8. Aerated Livewell System.....	19
9. Depth Gauge.....	19

VI. MAINTENANCE & CARE

1. Introduction.....	20
2. Gelcoat Care.....	20
3. Stainless Steel Rails and Fittings.....	20
4. Fuel System.....	20
5. Plumbing System.....	20
6. Livewell System.....	20
7. Electrical System.....	21
8. Hydraulic System.....	21
9. Carpet and Vinyl Upholstery.....	22
10. Windshield.....	22
11. Storage.....	22

INTRODUCTION

1. This Manual

The material here and in the rest of the Owner's Information Packet:

- Gives you basic safety information;
- Describes the fundamentals of boat use;
- Describes the features of your boat;
- Describes the equipment on your boat;
- Contains service and maintenance information.

You must learn to safely operate this boat as well as read, understand and use the information contained in this package.

Note: These manuals **do not** serve as a course in boating safety, or how to navigate, anchor, or dock your boat. Operating a power boat safely requires more skills, knowledge, and awareness than is necessary for operating a car or truck.

2. Your Responsibilities

For your safety, the safety of your passengers, other boaters and people in the water you must:

- Take a boating safety course;
- Get instruction in the safe and proper handling of your boat;
- Understand and follow the "Rules of the Road";
- Learn how to navigate;
- Register.

You must register this boat in the state where it will be used most frequently. Many states require additional registration when an out-of-state boat is used within their boundaries.

Contact state boating authorities or any marine dealer for registration requirements.

3. Sources of Information

In North America, contact one of the following for boating courses:

- U.S. Coast Guard Auxiliary
- U.S. Power Squadron
- Canadian Power and Sail Squadrons
- Red Cross
- State Boating Offices
- Yacht Club

Contact your dealer or the BoatUS Foundation at 1.800.336.2628

Outside of North America, contact your boat dealer and/or your governmental boating agency for assistance.

A book that provides a comprehensive background in boating is *Chapman – Piloting, Seamanship and Small Boat Handling*, by Elbert S. Maloney, published by Hearst Marine.

4. Dealer Responsibilities

In addition to a pre-delivery check and service of the boat, your dealer is to give you:

- A description and demonstration of the safety systems, features, instruments and controls on your boat;
- An "In Service Check List" form completed by you and the dealer after your inspection of the boat;
- A review of all warranty information and how to obtain warranty service;
- The Owner Information Packet.

If you do not receive these, or if you have any questions, contact your dealer.

5. Warranties

Your boat comes with several warranties. Each component and/or system on your boat has its own warranty that will be found with the specific information and manual for that component. These are included with your Owner's Manual Packet. The Century Boats Limited Warranty is on the warranty information sheet and is provided in this manual. Please locate and read the individual warranties.

6. Hull Identification Number (HIN)

The "Hull Identification Number" (Fig. 1) will be located either on the starboard side of the transom, or on the aft, starboard side of the gunwale, and is your boat's most important identifying factor. This number must be included in all correspondence and orders. Failure to include it creates delays. Also of vital importance when ordering parts for your engine is the engine serial number and part number. Refer to the Engine Operator's Manual for location of engine serial number and record it for future reference.

HULL IDENTIFICATION NUMBER LOCATION

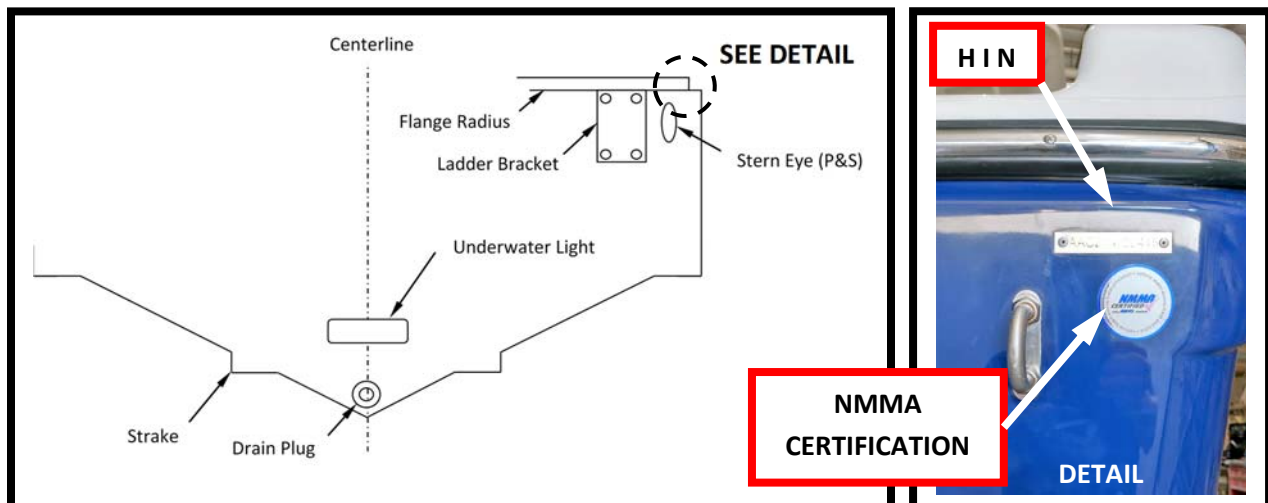

7. Manufacturer's Certification

As a boat manufacturer, Century Boats builds their products to guidelines established under the Federal Boat Safety Act of 1971. The Act is promulgated by the United States Coast Guard who has authority to enforce these laws on boat manufacturers that sell products in the United States. Century Boats ensures that all its products comply with these laws.

The National Marine Manufacturers Association (NMMA) provides Century Boats with a third-party certification. The NMMA is an organization that represents the marine industry and assists manufacturers, boat dealers, marinas, repair yards and component suppliers in areas of legislation, environmental concerns, marine business growth and state and federal government agency interaction. The third-party certification that Century Boats participates in uses the well-known Standards and Recommended Practices of the American Boat and Yacht Council (ABYC).

Century Boats participates extensively in the ABYC Council which is a nonprofit organization that develops and publishes voluntary standards and recommended practices for boat and equipment design, construction, service and repair. We utilize all applicable ABYC standards in the construction of all Century Boats.

Finally, Century Boats sells their products worldwide and as such must conform to the various rules and regulations required by other countries. Most notably, are the ISO standards in Europe which require the application of the Common European (CE) mark. This mark, like the NMMA certification here in the United States, gives the boat owner specific information concerning the craft.

8. Service, Parts & Repair for you Boat

When your boat needs service, parts or repair, take it to an authorized Century Boats dealer. To find a dealer in your area contact Century Boats at www.centuryboats.com.

To find repair and parts facilities for the equipment installed on your boat, refer to the section of the manual for that component.

If a problem is not handled to your satisfaction:

- A. **Discuss any warranty-related problems directly with the service manager of the dealership or your sales person. Give the dealer an opportunity to help the service department resolve the matter for you.**
- B. **If a problem arises that has not been resolved to your satisfaction by your dealer, contact Century Boats at www.centuryboats.com and the appropriate customer service information will be provided to you.**

SAFETY

1. Introduction

Safety afloat is the concern of all who enjoy water sports. An injury or accident will ruin any outing on the water. Always obey all laws and regulations. Follow the guidelines in this section and throughout the manual for safe, enjoyable boating pleasure. - Safety afloat begins with you.

Regulations vary from federal and local waters and from state to state; learn and obey the proper regulations. This is especially important for boundary waters between states.

This section covers general safety-related boating information. Throughout this manual, specific precautions are indicated by the following:

DANGER will appear above hazardous or unsafe practices information which WILL cause SEVERE injury, death or substantial property damage if warning is ignored.

WARNING will appear above hazardous or unsafe practices information which CAN cause SEVERE injury, death or substantial property damage if the warning is ignored.

CAUTION will appear above hazardous or unsafe practices information which WILL, or CAN, cause MINOR injury or property damage if the warning is ignored.

In addition, **NOTE** will appear above installation, operation, or maintenance information which is important but not hazard-related.

2. Required Safety Equipment

To comply with U.S. Coast Guard requirements your boat should be equipped with the following:

- A. An approved type B fire extinguisher
- B. Proper inland lighting for operation after sunset

In addition, you must supply one Personal Flotation Device (PFD) for each person onboard or waterskiing as well as one throwable type IV PFD; and with boats 16 feet and over, an approved sound warning device. Whenever going on an outing, verify that safety equipment is aboard and ready to use.

3. Personal Flotation Devices (PFD)

PFDs are intended to help you save your own life. You and your passengers should wear a PFD whenever boating. **It is especially important that children or non-swimmers wear a PFD at all times.** Make certain you know how to use PFDs. Try it on and make adjustments for a comfortable fit. Show children how to properly put on a PFD. There are three types of acceptable PFDs to wear and one type used for throwing in emergency situations.

NOTE

Special PFDs are available for skiing and other water sports. These PFDs are constructed with materials suitable for high impact falls into the water.

TYPE I LIFE PRESERVER:

- Has more than 20 lbs. of buoyancy and will turn an unconscious person slightly backward or vertical in the water.
- This type is good for non-swimming adults and when far from shore.



TYPE II BUOYANT VEST:

- Has more than 15.5 lbs. of buoyancy and will turn an unconscious person slightly backward or vertical in the water.
- A Type II PFD is more comfortable to wear than a Type 1 and is good for children.



TYPE III FLOTATION AIDS:

- Has more than 15.5 lbs. of buoyancy and will keep a conscious person slightly backward or vertical in the water.
- A Type III PFD can be used waterskiing or fishing.



TYPE IV THROWABLE DEVICES:

- Has more than 16.5 lbs. of buoyancy.
- A throwable must always be kept handy for emergency situations.



4. Recommended Equipment

In addition to required equipment it is important to store some additional items on the boat as a precaution. Here is a suggested list of recommended gear.

- Anchor and line
- Bucket or hand pump for bailing water
- Day and night visual distress signals, such as a flare gun (check local restrictions)
- Flashlight and extra batteries
- First aid kit
- Basic tool kit
- AM/FM radio with weather band
- Extra propeller
- Paddle

5. Alcohol, Drugs and Water Safety

Research shows that four hours of exposure to noise, vibration, sun, wind and glare produces a kind of “boater’s hypnosis” which can slow reaction time as if you were drunk. Adding alcohol intensifies this effect, increasing the chances of an accident.

WARNING

Never operate or allow another person to operate the boat while under the influence of alcohol or other drugs. 50 percent of all boating fatalities involve alcohol.

6. Rules of the Road

Just as there are rules of the road you must obey when operating a car, there are rules you must obey when operating a boat. You must be familiar with all rules before you operate your boat. The navigation aids (traffic signals) of the waterways are buoys, horns, signal lights, etc.

The Coast Guard has prepared many pamphlets for your information. For more information, contact a local U.S. Coast Guard station, write to U.S. Coast Guard Headquarters, 1300 NW Washington, D.C. 20226 or call the U.S. Coast Guard Boating Safety Hotline at 1-800-368-5647. Your local authorities can give you information on boat handling courses in your area.

7. Minors

Boats are not toys. Minors must be closely supervised by a competent adult whenever operating a boat. The state in which you operate may have laws regarding the minimum age and licensing requirements of minors. Be sure to contact your state boating authorities for information.

8. Passenger Safety

Make sure your passengers understand their responsibilities, such as wearing PFDs and remaining seated when moving. Show them how to operate the boat in case you are unable to continue operation, or fall overboard. Do not let them sit on the gunwale or over the bow. Do not allow them to drag their feet or hands in the water when the boat is moving. Instruct them to stay with the boat in case it capsizes.

WARNING

The operator of the boat is responsible by law to “maintain a proper lookout by sight (and hearing).” He must insist that he has an unobstructed view particularly to the front. No passengers, load or fishing seats should block his view when operating the boat above idle speed.

9. Waterskiing**WARNING**

Skiers must wear a U.S. Coast Guard approved PFD suitable for water sports.
Keep well away from all other objects.
Have an observer in the boat watch the skier at all times.
Do not ski in shallow water.
Always keep a downed skier in sight and check for the skier's OK signal immediately.
Turn off motor before getting close to downed skier.
Do not ski at night or in crowded waters.
Never back up to the skier or anyone in the water.

To connect the water ski tow rope, use a bridle (available at your dealer) which connects to both rear tie-down eyes on the transom and connect to the ski eye if your boat is equipped with one. The bridle should be long enough to not hinder engine tilt ability, but not so long that it could get caught in the propeller.

The boat should start at slow speed until the tow rope is taut. Check that the way ahead is clear and apply enough power to raise the skier. When the skier is up and signals the OK, adjust speed according to the skier's hand signals.

A boat operator should never drive his boat directly behind a water skier. At 25 mph, the boat will overtake a fallen skier who was 200 feet in front in five seconds.

When a skier falls, watch for the OK signal. Circle around to get the tow line to the skier for getting up again or boarding the boat. Approach the skier with the right side of the boat and help the skier board from the stern. Pull in the tow line and retrieve the skis.

For more information on waterskiing contact: American Water Ski Association, P.O. Box 191, Winter Haven, FL 33880, (813) 324-4341.

10. Swimming

When driving the boat, slow down and watch for swimmers outside of marked swimming areas. Be alert for divers and be familiar with the divers down flag. Keep the boat well away from marked swimming areas and divers.

Never swim alone from the boat. Swim near the shore and away from boating traffic. Anchor the boat before swimming and stow the keys and valuables on board.

11. Hazardous Weather

When dangerous wind or sea conditions exist, stay home! Getting caught in severe weather is hazardous. Check with local weather stations, the U.S. Coast Guard, or Weather Service broadcasts (162.55 or 162.40 Megahertz) for the latest conditions. It is recommended to check the weather not only before, but also periodically while you are boating.

When you are on the water watch for these signs of hazardous weather:

- Dark threatening clouds
- Increasing wind strength and wave action
- Static on AM radio indicating thunderstorms
- Fog
- Lightning

If you get caught in hazardous weather:

- Put on PFDs
- Head for shore
- Secure loose items in the boat
- Seat passengers on the floor of the boat, near the center line

12. Hazardous Conditions

Every waterway poses hazards that need to be avoided – shallow water, tree stumps, sand bars, etc. Prevent damage to your boat, or harm to yourself and passengers, by becoming familiar with the body of water you are boating on. Ask other boaters for information and consult a Boats Chart when boating on unfamiliar waters.

13. Accidents

Sometimes accidents happen. Be prepared to deal with accidents before they happen. Here are some guidelines to follow in case of an accident.

A. Personal Locator Beacon (PLD)

The PLD is a device which every boater should consider having on-board. It transmits a signal to indicate your position to the U.S. Coast Guard.

B. Distress Signals

It is a good idea, and in some cases legally required, to carry visual distress signals on the boat. There are three types of U.S. Coast guard-approved visual distress signal devices; day use, night use and day and night use. Read and follow the instructions included with the type of visual distress signal you purchase. Check local restrictions on pyrotechnic devices.

C. Accident reporting

Accidents include capsizing, collision, flooding, fire, explosion, loss of life or equipment. The operator of the boat is responsible for filing a report with the appropriate authorities. In general reports are necessary for accidents involving loss of life, injury, or damage more than \$200. Ask your insurance agent for more detailed information.

D. Giving Assistance

If you see a distress signal, you should act immediately. Notify the nearest Coast Guard station or state authority by radio. Channel 9 on CB and channel 16 on VHF Boats radio (156.8 MHz) are recognized distress channels. If you can assist a stricken boat without endangering yourself, you should.

It is an unwritten law of the sea that a boater comes to the aid of another boater in trouble. The Federal Boat Safety Act of 1971 grants "Good Samaritan" protection to a boater offering good faith assistance in case of an accident or casualty.

E. Fire on Board

Most fires are the result of accumulated gasoline and oil in the bilge from careless fueling practices combined with the thoughtless use of smoking materials.

Deciding on whether to fight the fire or abandon the boat is difficult and depends on many factors. Make sure to formulate a plan, that will allow you to make that decision quickly and without hesitation.

F. Capsizing

Certain conditions can arise where a boat may be capsized or swamped. Most often, these conditions happen when least expected. Like fires, make sure you formulate a plan on what to do if it should happen.

G. Towing and Being Towed

Use caution when towing or being towed. Use high-quality rope capable of the load. Keep at least two boat lengths between boats. Never tie onto cleats, handrails, windshields or attempt to hold on to the tow line; use the bow eye on the boat being towed and both stern eyes on the tow boat to distribute the load. Proceed slowly and don't try to tow a much larger boat. Always ask yourself if it would be easier to anchor the distressed boat and bring back help; i.e.; running out of fuel.

H. Unassisted Re-boarding

If you are on your boat alone, and are thrown overboard you will need a plan for safely re-boarding your boat unassisted. It is recommended that before you leave the dock that you take your stowed ladder and place it in the mounting bracket in the inverted position (It is highly recommended you do this every time, even if you are not alone). Then in the event you are thrown into the water alone and no one is on the boat you will have access to the ladder. You can then swim up to the rear of the boat (avoiding the propellers on the motors), pull the spring-loaded pin, carefully remove the ladder from the bracket, and invert it into the boarding position. Place the ladder back into the mounting bracket and secure the locking pin. You can now release the rungs of the ladder and re-board your boat. It is also recommended that you instruct and practice this procedure with anyone who might use your boat.

I. OPERATIONAL HINTS

1. Fueling the Boat

Your boat is equipped with a built-in fuel tank. Fuel fill location will differ depending on the model you have purchased.

WARNING

**Gasoline is very flammable.
Never smoke or allow flames or sparks near the fuel tank, filler or vent.
Shut the engine OFF before refueling.
Use extreme care when filling fuel tanks in hot weather.
Do not fill the tanks completely.**

Gasoline expands during warm days, causing pressure to build in the tank. This expansion can lead to fuel leakage, which is a potential fire hazard.

A. Filling Tank

- If filling from a dock fueling point, secure the boat to the dock and turn off all equipment and shut off the engine.
- Remove the cap and insert the fuel supply nozzle, keeping the nozzle in contact with the fittings to reduce the danger of static sparking.
- Add fuel.
- Replace the fuel and wipe up any spillage.
- Check oil injection tank, if equipped, for proper level. Refer to the engine operator's manual.

2. Capacity

Your boat has a maximum weight and horsepower capacity plate located inside the boat near the console. Know your boat's maximum ratings and don't overload the boat. Remember, the load capacity rating includes passengers and equipment. If you should replace the engine, never exceed the recommended maximum horsepower.

WARNING

Failure to observe the maximum weight and horsepower capacity could lead to conditions resulting in an accident and severe injury.

3. Boarding

Always step, not jump, into the boat when boarding. Board one person at a time. Get in the boat and then lift equipment aboard. Do not carry heavy or cumbersome equipment while you are boarding. Follow the same procedure when getting off the boat. Always stow equipment in the storage compartments.

WARNING

To help prevent passengers from being thrown overboard resulting in severe personal injury or drowning, all passengers should be carefully seated and not be riding on the deck, gunwale, rear sun deck, or elevated pedestal fishing seats while underway. Passengers in the bow rider seats should relocate to the aft passenger seats.

If your boat is equipped with non-adjustable pedestal seats, the pedestal pole should be removed and stowed in a compartment when the boat is moving faster than trolling speeds.

4. Boat Weight Distribution

Weight distribution affects the performance of your boat. Keep weight in the boat low and distributed evenly. To get the boat on plane faster and performing at its best, avoid having too much weight in the bow or stern.

NOTE

The maximum capacity rating is based on normal boating conditions. In bad weather reduce the load to improve the boat's trim.

II. Basic Operation

1. Introduction

This section will briefly cover the basics of operating your boat. The controls are explained in more detail in the Control, Engine and Steering systems operator's manuals included in the Owner's Information Packet furnished with your boat.

2. Shift/Throttle

The shift/throttle is the unit that controls the neutral, forward and reverse direction of the engine. The shift throttle also acts as the "gas pedal" and controls the speed of the boat.

WARNING

Do not shift too quickly from forward to reverse. Stay in neutral or idle position until the boat has lost most of its headway before completing the shift to reverse.

Moving the control forward increases speed, neutral is the center position and moving the control to the rear puts the boat in reverse. Consult the engine and shift/throttle operator's manuals for more detailed information concerning operation of this unit in conjunction with the engine.

3. Safety Stop Switch and Lanyard

WARNING

Attach the Safety Stop Switch lanyard to your clothing before starting the engine. This will prevent the boat from becoming a runaway if you are accidentally thrown from the boat.

The Safety Stop Switch can only be effective when it is in good working condition. Observe the following:

- Never remove or modify the Safety Stop Switch and/or lanyard.
- The lanyard must always be free of entanglements that could hinder its operation.

Once a month, check the switch for proper operation. With engine running, pull the lanyard. If the engine does not sleep, see your DEALER for replacement of the switch.

Your boat may be equipped with a safety stop switch and lanyard. This is a device designed to turn off the engine ignition whenever the operator, when attached to the switch lanyard, moves far enough away from the operator's position to activate the switch. It is strongly recommended that the operator make use of the safety stop switch. The lanyard should be of sufficient length to avoid inadvertent activation. Accidental loss of power can be hazardous particularly when docking or in heavy seas, strong current or high winds. There are practical limitations to what the lanyard stop switch can do. It can take several seconds for the engine and propeller to stop turning and the boat can continue to coast for several hundred feet depending on the velocity at shut down, and the degree of any turn, however, it will not complete a full circle. While the boat is coasting, it can cause injury to anyone in the boat's path as seriously as the boat would when under power.



Safety Stop Switch & Lanyard

4. Steering

All models are equipped with a steering wheel that operates like a car. Others are hydraulic and use fluid under pressure to turn the engine.

5. Getting Underway

Always prepare the boat before each outing. Is the safety equipment in place and ready to use? Is other equipment (seats, gear, etc.) stored properly? Are the fuel and oil tanks filled? Have you checked the weather? **Preparation is the key to an enjoyable outing.**

Know the "Rules of the Road" when boating. There are right and wrong ways to overtake, meet, cross, etc. with other boats. The U.S. Coast Guard, state boating authorities and many agencies have information and courses covering the rules of the road, safety, navigation, and many other topics.

For operation after sunset, boats are equipped with navigation lights to give information about direction. A green light is on the starboard side of the boat, a red light on the port side, and a white light at the stern. If a red light is visible, that boat is privileged and has the right of way. If a red and green light are visible, the other boat is heading toward you and both boats must move. Sighting a white light indicates the other boat is moving away from you, or is anchored, and if you are overtaking, the boat ahead is privileged.



6. Maneuvering

When underway for the first time, practice making turns in both directions. Become familiar with the way your boat handles. Boat handling is affected by the load, wind and water current. These conditions vary on every outing, so always use caution when maneuvering your boat.

Boats handle differently than cars. All boats steer from the stern. The stern of the boat will swing out in the opposite direction of the bow when turning. This is important when making fine maneuvers like docking.

A boat has no brakes. To stop a boat, slow down to “no wake speed”, pause in neutral, and put the engine in reverse. Gently increase reverse power to stop at a short distance. Keep in mind that boats do not steer well in reverse. Go slow to prevent taking water in over the transom.

Know your position and know where you are going. There are several forces that can affect your boat's direction when underway.

Besides driving the boat forward, a clockwise rotating propeller can cause the boat to move to the right as it goes forward and to the left when going in reverse. This effect is not noticeable when you are going fast but becomes apparent at slower speeds.

7. Docking/Departure

Practice docking before attempting it for the first time. Use a float, like a plastic milk jug with a line and small weight, as your docking target.

A. Docking Guidelines

Follow these guidelines when docking:

WARNING

Never use your hand, arm or other part of your body to fend the boat off the dock. The boat could push against the dock, causing an injury.

- Come to a stop a short distance from the dock.
- Have fenders and mooring lines ready.
- Observe how the wind and current are moving your boat.
 - Approach the dock with the boat pointed into the wind, if possible. If the wind or current is pushing you away from the dock, use a sharper angle of approach.
 - If the boat is being pushed toward the dock, approach parallel to the dock and allow the wind and current to push you to the dock.
 - If you must approach the dock downwind or down current, use a slow speed and shallow angle.
 - Be ready to reverse to stop and maintain position. In this case secure the stern line first.
- If there is no wind or current, approach the dock at a 10° to 20° angle.
- If possible, throw a line to a person on the dock and have that person secure a bow line.
- With the bow secured swing the stern in with the engine or pull it in with a boat hook.
- Tie mooring lines to the bow and stern of the boat. To protect your boat, keep fenders between the boat and the dock.

B. Leaving the Dock

The procedure for leaving the dock is similar to the docking maneuver.

A. If the wind or current is pushing toward the dock:

- Cast off the stern line but keep the bow secure. Turn the engine to move the stern away from the dock.
- Very slowly shift into forward at idle speed. When the stern moves away from the dock, turn the engine away from the dock. Cast off bow line and back away.
- When clear of the area, shift into forward and leave.

B. If the wind or current is pushing away from the dock:

- Cast off all lines.
- Drift off and when clear of the dock, shift to forward and leave.

8. Trim / Propeller Selection**A. Trim**

Boat trim while underway greatly affects boat performance and efficiency. For best results, the boat should be on plane and trimmed to reduce the wetted surface. With less boat in the water, both speed and fuel mileage increases.

- Trim the engine in. As you speed up, your boat will increase its angle of trim, causing the bow to rise. You can limit this effect by adjusting the angle of the engine. The propeller needs to be trimmed in to force the bow down and force the stern up at the start of a run.

WARNING

Always keep one hand on the steering wheel and other on the throttle. If the boat begins to operate in an unsafe way pull back on the throttle and trim the engine in at the same time.

- Increase speed. The bow will start to come down.

WARNING

Do not trim the engine out too far or the boat may begin to “porpoise” (bounce up and down). Porpoising lowers top speed and fuel efficiency and reduces control and visibility.

- Once on plane, the engine should be trimmed out a little to avoid a bow down condition called “plowing.” Plowing can cause “bow-steering” or “oversteering” and inefficiently consume horsepower. In this condition, if attempting a turn or encountering diagonal moderate wake, a more abrupt turn than intended may result.

WARNING

To avoid possible serious injury or death, adjust the engine to an intermediate position as soon as the boat is on plane to avoid possible ejection due to boat spin-out. Do not attempt to turn the boat when the engine is trimmed extremely under or in.

High speed operation in rough water requires quick reactions and adjustments to maintain control. Know your limits and stay within them. Slowdown in rough seas. Always keeps one hand on the steering wheel and the other on the throttle; constant adjustments are necessary for rapidly changing conditions. Small inputs of throttle and steering are exaggerated at high speed.

Watch the tachometer to keep the engine within the full throttle operating range. See the engine Operator's manual for the proper tachometer reading at full throttle.

9. Anchoring

When anchoring, it is helpful to keep a few guidelines in mind.

- Make sure the line is tied to the anchor.
- Tie the other end of the line to the forward cleat or bow eye.
- Head the boat into the wind or current over the spot where you want to lower the anchor.
- Stop the boat before lowering the anchor.
- When the anchor hits bottom, slowly back up the boat, keeping tension on the line. Let out an anchor line that is 4 to 6 times the depth of the water. For example, if you are in 10 feet of water, let out 40 to 60 feet of line.
- Check your position against the shoreline. If you are drifting, reset the anchor.
- If you have a windless (power anchor), be sure you test it prior to going out.
- Do not anchor from the bow and stern at the same time.

III. SYSTEM/COMPONENTS

1. Instrument/Switch Panels

All gauges are illuminated for operation after sunset. An explanation of the instruments, switches and controls follows. Their number and location vary by model; some may not appear on your model.

A. Tachometer

Registers engine speed in revolutions per minute. Use this gauge to keep the engine within the proper operating range. Consult the engine manual for the proper RPM operating range for your engine.

B. Speedometer

Registers forward boat speed in miles per hour. Use this gauge to monitor fuel consumption and propeller performance.

NOTE

Boats speedometers, which operate with water pressure, may not be accurate.

2. Electrical System

Your boat is equipped with a 12-volt negative ground DC system. Battery location will vary from model to model. Each battery in your boat will independently power its own system (i.e.: house battery will power the house system; engine battery will only power the engine).

The cranking battery/s are recharged by the alternator when the engine is operating. When the battery/s reach full voltage, the installed DSVR will shift the charge over to the house battery to help maintain its performance throughout the day.

3. Fuses and Breakers

All Century Boats are equipped with circuits protected from an overload. In the event of an overload or short circuit, the fuse will blow out or a circuit breaker will trip. If a circuit continuously overloads under normal operating conditions, have your boat inspected by the dealer immediately.

Each individual circuit is protected with a breaker located in the console, switch panel, fuse panel or at the cranking battery switch panel. Fuse and Breaker sizes vary depending on model, check with your dealer for correct size.

CAUTION

Do not exceed the recommended fuse sizes. Always install the proper (type and rating) fuses whenever replacing or changing fuses. Continuous fuse failures indicate a severe problem and requires immediate attention. Failure to install the correct fuse may result in damage to the electrical system or severe personal injury.

4. Switches and Controls

All switches used are rocker types. Many switches have red LED indicators for positive ON/OFF identification.

A. Lights (Navigation and Anchor) Switch

Three-position switch that controls the running lights.

- NAV position will turn on the red and green bow lights, white stern light and gauge illumination lights for night operation.
- ANC turns on stern light only for night anchoring (do not operate the boat with switch in ANC position).
- OFF is center position.

B. Bilge Switch

Two-position ON/OFF switch that activates the bilge pump to remove excess water in the bilge.

C. Aerator Switch

Two or three-position switch that activates the aerator pump to add water to the live well.

- ON position is used to continuously add water to the live well.
- OFF is center position (three position switch only).

D. Accessory Switch

Two-position ON/OFF switch used for optional equipment (be sure to fuse any accessories you add).

NOTE

A warning horn is in the ignition wiring harness that will alert you to possible engine problems. This warning horn has a self-testing feature and will emit a short tone whenever the engine is started. For more information, about the warning horn, consult the engine operator's manual.

E. Safety Stop Switch and Lanyard

Stops the engine when engaged. Attach the lanyard to the boat operator whenever the motor is running. If the operator moves far enough away from the operator's position the lanyard will engage the switch and shut off the engine. For more information about the stop switch, see the Operational Hints section and the engine operator's manual.

5. Shift/Throttle

A binnacle control unit that regulates speed and allows you to select forward or reverse gear. For more information about the shift/throttle, see the Operational Hints section or consult the operator's manual that came with the unit.

6. Fuel System

Models equipped with a built-in fuel system meet current federal regulations. The fuel level of the gas tank can be monitored by the fuel gauge located on the instrument panel with the ignition switch in RUN position.

A vent allows air to move in and out of the tank as the fuel level changes. If the fuel tank is overfilled, some fuel may come out of the vent.

Check all fuel system components before each season and inspect regularly during the season for any leaks, bad hose connections or blockages. It is important that the fuel system is leak-free. See the Maintenance/Care section for more information.

7. Bilge

The lowest part of the boat where incidental water drains is called the bilge. Water drains into the bilge during rainy weather or heavy storms. Some models are equipped with a bilge pump to remove this water through the hull. The bilge pump is in the bottom, aft of the boat near the drain plug.

To operate the bilge pump, engage the bilge switch; the pump will operate if the switch is engaged. If there is any water in the bilge, it will shoot out from the bilge drain opening. Be sure to turn off the bilge switch to avoid damaging the pump after the water is drained.

Occasionally check that debris is not jamming the pump impeller. Periodically inspect the electrical connections to make sure that they are waterproof. All plumbing must be secure because most of the pump is below water level and a leak will allow water into the boat. See the Maintenance/Care section for more information.

8. Livewell System

Livewell systems have a single pump that circulates water to the livewell through the spray nozzle. Some models may be equipped with a livewell drain and a built-in overflow. Water will drain overboard when the level reaches the overflow opening in the livewell. To drain the livewell, remove the drain plug from the drain hole.

CAUTION

To avoid damage to the livewell system, never operate in freezing weather. Operating the pump in freezing weather could damage or break the pump. Water that freezes in hoses will expand and could burst the hose.

Livewell systems can only be used when the boat is in the water. To operate:

1. Push the drain plug into the drain hole.
2. Check the seacock in the bilge and insure it is in the open position (handle straight up).
3. To operate the livewell pump switch on the switch to the on position. The tank will start to fill up. Once the tank is full, it will recirculate water through the overflow drain if the switch is on.
4. If no water is flowing, you may have trash blocking your livewell scoop. Turn off the pump and try running your boat in reverse for a few minutes, then check again. If that does not work: If you have a trailer, load your boat on the trailer and check the scoop for trash. If you do not have a trailer and do not have the proper knowledge on how to check out the problem, take your boat to the dealer.
5. To drain the livewell tank, turn livewell pump OFF and remove the drain plug from the drain hole.
6. Close the seacock.

9. Depth Gauge

Some models are equipped with a factory installed depth gauges. The depth gauge will provide you with a reading of the depth of the water in which the boat is navigating.

IV. Maintenance / Care

1. Introduction

Your new Century is manufactured of quality materials and components. With proper care and maintenance, your boat should provide you with many years of enjoyment. We suggest the following procedures for maintaining your boat. Always consult your Century dealer for care and repair products and services.

2. Gelcoat Care

Use cleaners and waxes specifically formulated for use on fiberglass boats. This is extremely important to maintain the factory finish. Always clean your boat after use especially when used in salt-water. Consult your dealer for recommended products.

WARNING

If the boat is to be left in the water for any period, the use of a bottom sealing paint, professionally applied, is strongly recommended to avoid blistering of the hull.

3. Stainless Steel Rails and Fittings

Stainless steel goes through a chemical treatment called passivation. This will not prevent corrosion in crevices, within flanges, and under fastener heads. Stainless steel will darken with time losing its original luster. The effects of salt water accelerate the breakdown of passivation. Century uses high-quality stainless steel parts. It is very important that as part of the overall maintenance of your boat that attention be given to the stainless steel. Use a high-quality, stainless steel polish on all stainless fitting to prolong the appearance of your boat consult your dealer for recommended products.

4. Fuel System

It is important to prevent leaks to the fuel system. Once a year, inspect the fuel hoses, hose connections and fittings for wear or leaks. Stains around joints could indicate a leak. Check connections and fittings for tightness using a wrench. Do not over tighten. Replace hoses that have surface cracking. Clean fuel filters and vent screens.

5. Plumbing System

Over time, the bilge may accumulate oil, which is a fire hazard.

To clean the bilge, pump the bilge dry and remove all loose dirt. Use a car wash, liquid household detergent or a commercial bilge cleaner to clean out the bilge. Do not use flammable solvents. After cleaning, rinse the bilge thoroughly with freshwater to remove any remaining cleaning solution. Periodically check that debris is not jamming the bilge, the live well or aerator pump screen.

6. Livewell System

Use only freshwater when cleaning the live well. Any residual amounts of soap, detergents, bilge cleaners, etc., may kill your catch.

7. Electrical System

Make sure the batteries are secure. Check that battery connections are clean and tight. If not used frequently, trickle charge the battery to keep it ready for use. Follow the instructions included with the battery charger.

WARNING

When charging, batteries produce hydrogen gas which is extremely flammable. Never smoke or allow flames or sparks near batteries. Failure to adhere to these instructions may produce an explosion and cause serious injury or death.

- Keep the battery terminals free of corrosion. Clean the terminals regularly with a baking soda and water solution and a plastic bristle brush. Coat the cable end lightly with petroleum jelly.

CAUTION

Do not allow the baking soda and water solution to enter the battery vents. The solution will damage the battery if allowed to enter.

- Check the electrolyte level on non-maintenance free batteries at least once a month and fill with distilled water. Do not overfill the batteries. Overfilling may cause terminal corrosion and short battery life.

WARNING

Wiring that is damaged or not properly supported may cause a serious short circuit hazard if not immediately corrected.

- Check all the wiring to make sure it is properly supported and the insulation is intact. Consult the engine operator's manual for care and maintenance of the engine's electrical system.

8. Hydraulic Steering

If your boat is equipped with hydraulic steering, check hydraulic steering system for leaks and fluid level. If necessary, tighten hose connections. Replace defective hoses. Refer to the manufacturer's manual for fill and maintenance instructions.

9. Vinyl Upholstery

On vinyl upholstery use a vinyl preservative wax to keep it clean and soft. Harsh detergents such as bleach and solvents can cause permanent damage.

CAUTION

Some popular fish scents that are sprayed on lures contain chemicals that may cause deterioration of the carpet and upholstery. Spray these formulas away from the boat.

Consider using a mooring cover to protect the interior of the boat from the effects of sun and weather, and to keep debris out.

CAUTION

If the carpet or upholstery should be damaged by mildew, special cleaners are available that may help. Be sure to test the cleaner in a hidden area first.

10. Windshield

Windshields are made of tough acrylic plastic or tempered glass, depending on the model. Even though the windshield is made to withstand minor impact, it is susceptible to scratches. Never clean it with a dry towel; or use strong cleaners or abrasives. Use only a mild soap and water solution with damp towels.

11. Storage

Proper care in preparing your boat for storage will help protect your investment and make getting ready again for next season easier.

CAUTION

If improperly stored, the boat could take on water which can accumulate and cause damage to on board systems.

Proper care includes preparation of the engine, boat and components for storage. For information regarding proper storage procedure for the engine, see the engine operator's manual.

When preparing your boat for storage follow these guidelines:

- Fill the fuel tanks to minimize condensation. Use a gasoline stabilizer, following the instructions on the container. Run some stabilized gas through the engine before storing the boat.

NOTE

Do not overfill fuel tanks. Allow room in the tanks for expansion.

- Prepare engine for storage. Refer to engine operator's manual for proper procedure.
- Thoroughly clean the boat. Clean the hull, deck and storage areas as soon as the boat is removed from the water.
- Remove the drain plug and raise the bow of the boat to allow any water to drain. Remove any water from the live well and other compartments.
- Wax the boat and apply a rust inhibitor to all metal parts.
- Remove the batteries from the boat. Clean, charge and store the batteries where they will not freeze.
- Lubricate steering mechanism and throttle control.
- Store the boat under a cover. The covers should keep the weather off the boat but still provide adequate ventilation to avoid mildew damage. If the boat is stored outside, additional supports under the cover may be necessary to prevent pockets that will collect snow or rain. This can add extra load to the hull and trailer; also, stress to the cover, possibly tearing it.
- Loosen the stern tie downs to reduce stress on the hull
- If stored on the trailer, block the trailer wheels off the ground to avoid tire deterioration.
- Inspect the hull bottom contours. Deflections may indicate overloading or improper trailer support. Boats should be supported without an excessive overhang off the back of the trailer.

Follow these guidelines when reactivating the boat:

- Perform annual maintenance if it was not done before storage.
- Inspect storage areas for nesting animals.
- Prepare the engine for a new season. See engine operator's manual.
- Install charged batteries into the boat.
- Check all hose clamps for tightness.



CENTURY BOATS
40047 County Road 54 East
Zephyrhills, FL 33540
813-CENTURY
CenturyBoats.com